

29484E

Dimensions

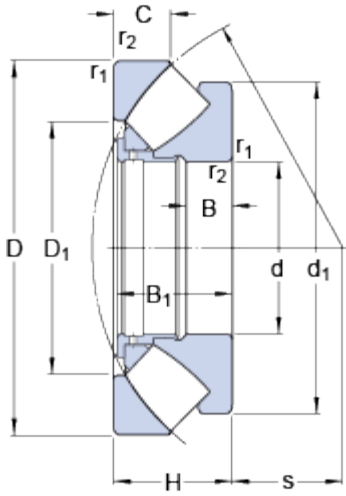

d	420	mm
D	730	mm
H	185	mm
d ₁	≈ 665	mm
D ₁	≈ 545	mm
B	70	mm
B ₁	178	mm
C	90.5	mm
s	244	mm
r _{1,2}	min. 7.5	mm

Abutment dimensions

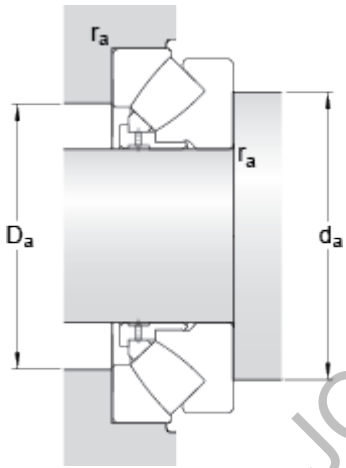

d _a	min. 575	mm
D _a	max. 635	mm
r _a	max. 6	mm

Calculation data

Basic dynamic load rating	C	7800	kN
Basic static load rating	C ₀	27500	kN
Fatigue load limit	P _u	2080	kN
Reference speed		480	r/min
Limiting speed		850	r/min
Minimum axial load factor	A	69	

Mass

Mass bearing		325	kg
--------------	--	-----	----